



Raised  
**Access Floor**

---

 **POLYGROUP**

Polygroup is a high tech raised access floor system manufacturer and innovative flooring solutions based in Spain (E.U.) since 1975. The organization and effectiveness of our technical and commercial network have been a decisive factor to the growth and development of a wide and diversified market in Europe, America, Africa and Asia, taking part in projects to over 50 coun-

tries reinforcing our structure with solid collaborators strategic alliances. Our unique relationship with architects and designers gives us an unrivalled insight into what they really want from building product manufacturers. We offer innovative technology, high production capacity and customized service striving for excellence on each project we are involved.

Our continuous investment in research and development ensures that the full range of products performs at its best even in the most demanding, difficult and diverse of installations. We have wide experience and recognition of many international architects, designers and engineers which entrust their projects to us for years. Our expertise team is giving our col-

laborators network technical support and brilliant know-how providing full coverage from initial stage submission to practical completion of the flooring installation. Nowadays, through of the international position that our company has acquired, we can offer the best advice and services to our clients, such as the most advanced technical solutions for each project.

 POLYGROUP



# INDEX

Polygroup	03
Research & Development and Innovation	06
Quality	08
Commitment	10
<b>INDOOR</b>	<b>12</b>
<b>Gamaflor System</b>	13
PAC	14
BANK	18
Pac / Bank SOVEREIGN	22
FULL STEEL	26
STRUCTURE	34
Light finishes	36
Hard finishes	38
Accessories	40
Applications	42
<b>OUTDOOR</b>	<b>46</b>
Gamaflor Out-Floor System	47
<b>UFAD</b>	<b>50</b>
Gamaflor Eco Thermal System (GETS)	51
<b>DATA CENTER</b>	<b>54</b>
Data Center System	55
Contact	62



# R & D

RESEARCH & DEVELOPMENT AND INNOVATION

Our company's workforce is based on combining technical knowledge, experience, dependability, creativity, flexibility and the highest standard of customer service. Our Technical Expertise Team can analyze your specific flooring need and carefully design an accurate System that will meet your performance and budget requirements.

A continued I+D+I investment, the rigorous quality policy in our products and the environmental engagement, places our raised access floor systems in an undisputed position among the most competitive companies in the sector.

## Tailored solutions

Through strong focus on innovation and well-established cooperation with excellent research centers and institutes, Polygroup effectively covers important areas of technological know-how distinguishing our expertise branches between commercial and technical products and projects. This intangible asset is hard for competitors to imitate, which makes them a powerful source of sustainable competitive advantage.

The new raised access floor generation we are creating is being fully accepted by the new design and building construction concepts of offices, open spaces contributing in creating new, diverse and versatile kinds of purposes for designing spaces more alive and dynamic than ever.





# Quality

The raised floor industry quality parameters, must meet the requirements established by 2 main International Standards, **ASTM-CISCA American standards and UNE EN 12825 European Standards**. Both of these are very strict in regards to control the raised access floor system mechanical compliance.

Polygroup is one of the few companies worldwide that have all its products range **tested by international independent laboratories** under American and European Standards, gaining **customers satisfaction** no matter the final market destination of the systems.

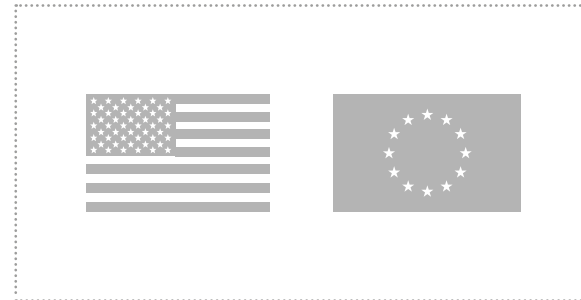

During our production process, every component is regularly checked with our own precision measurement equipment laboratory following a rigorous control method to the highest standard aforementioned.

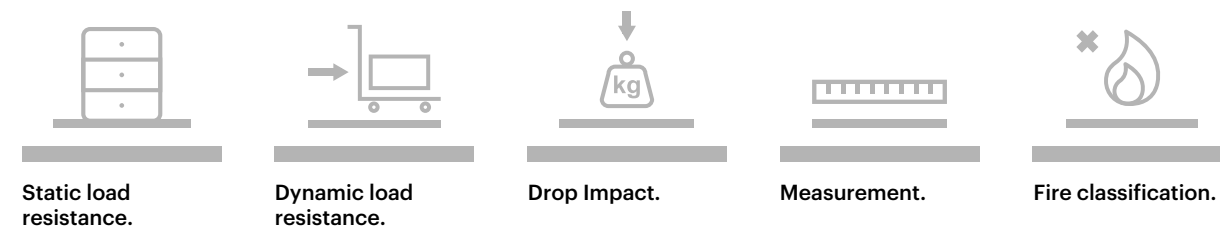

Our rigorous and detailed technical control processes allow us to yield more advanced test features of our systems such as: **thermal and electrical conductivity, peel strength, acoustic and anti seismic test** to those customers who require a personalized study in compliance with a particular high tech specs project.

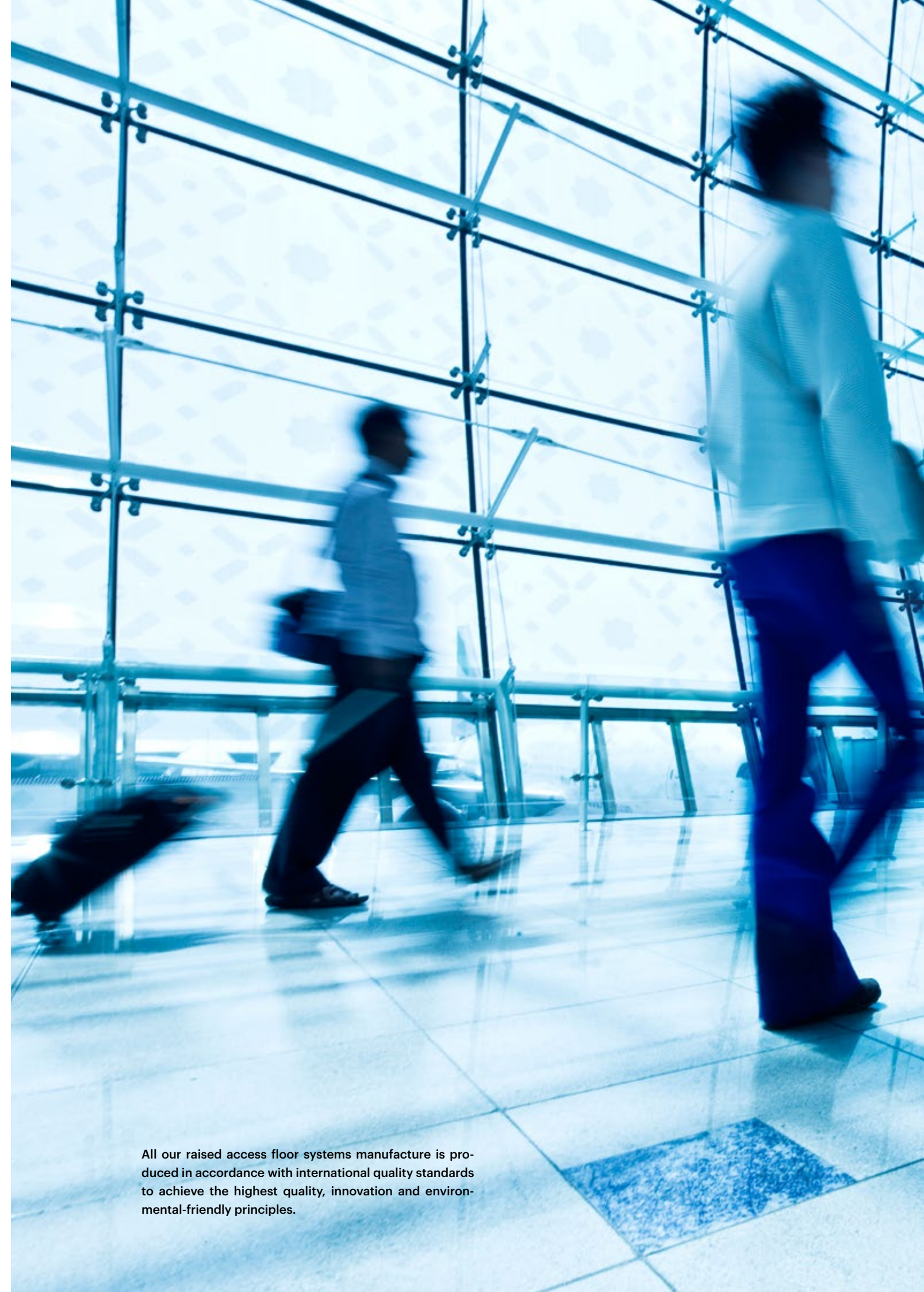
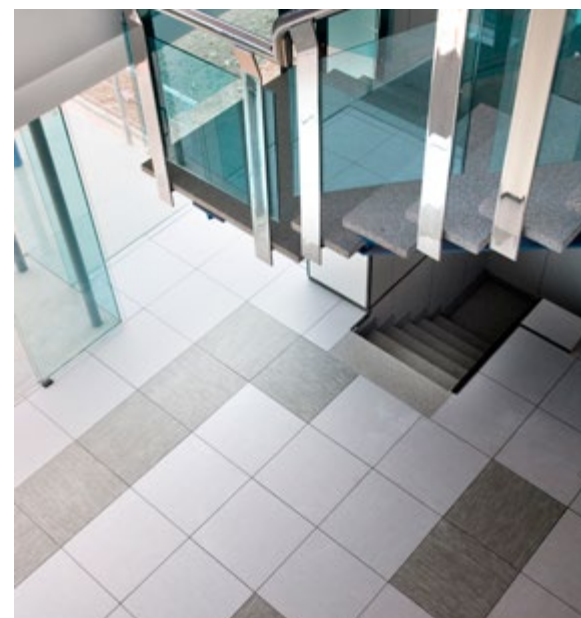
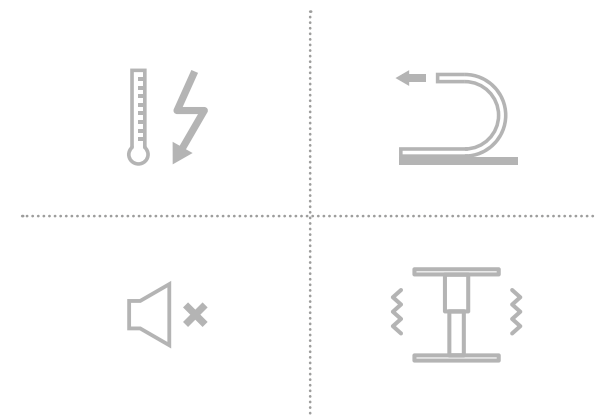

All our raised access floor systems manufacture is produced in accordance with international quality standards to achieve the highest quality, innovation and environmental-friendly principles.



# Commitment

/ 10

Raising Green / Ongoing Green / Working Green / Earth Conscience / Earth Friendly

*"Polygroup, taking a step forward on the green side".*

Polygroup is an earth conscious and sensitive towards environmental issues company, that operates in the construction business with a strong focus on technological innovation, energy saving, protection of health and the habitability conditions.

## 62% RECYCLABLE MATERIAL AFTER USE



62%

Particular sensitivity to saving energy, protecting the environment and safeguarding health, combined with analytical skill and methodological rigor characterize the company's research efforts and will increasingly be the center of focus, allowing us to create original solutions and identify innovative applications that translate into concrete proposals for a constantly developing market.

This is the reason why our products manufacture incorporate sustainable practices contributing to a constant improvement of its performance on behalf of Polygroup's "On Going Green" Ethos.



## WATER BASED VOC FREE ADHESIVE

Most of the adhesive materials contain VOCs that, in terms of short-time exposure are not harmful. However, inside buildings and installations where the airflow is minimal, they can be one of the leading hazards to human health caused by substances that infiltrate the air indoors leading to health risks. The glues and adhesives used in our raised access floor production has very low or nil VOC levels.



## RECYCLED RAW MATERIAL

Polygroup manufactures its raised floor systems using huge average of recycled raw material. The chip-board core is certified by the reputable accredited authority Forest Stewardship Council (FSC).



## 100% RECYCLING OF RAW INDUSTRIAL WASTE

The raw material waste discarded during the production process is sent to external specialized collaborators to be recycled.

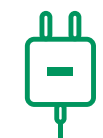

## ENERGY SAVING

Production lines and time schedules are synchronized leading to unnecessary energy usage.



## 100% RECYCLED PACKAGE

All the materials used for the packaging of our Systems (boxes, thermo-retractable, labeling, pallets and the like) are totally recyclable.



## LEED RATING SYSTEM

Leed Standards (Leadership in energy and environmental design) are eco-sustainable building parameters developed by the Green Building Council in the US and applied to over 40 countries worldwide. Is a voluntary certification system based in the allocation of points for every eco-sustainable requisite of a building. By adding up the points awarded, a total points rating is obtained.

# Sustainable responsibility



LEED offers an all-round approach towards environmental issues taking into consideration the performance of a building in relation to six key topics:

- > Sustainable sites
- > Water efficiency
- > Energy & Atmosphere
- > Material & Resources
- > Indoor environmental quality
- > Innovation in design

Polygroup products contribute to the **LEED Building Rating Systems** requirement for Recycled Component Materials, reusable Materials and Indoor air quality which represents the excellence in the management of all practices relating to environmental impact.



# Gamaflor System

---

INDOOR

---

#### What is a Modular Raised Floor System?

*"An assembly of components concerned with interdependent functions, forming a unitary whole solution".*

Gamaflor System enhances solutions to the highest level helping to develop new insights into the interaction of raised floor systems components. Together we strive for the overall objective of the whole starting for the steps we take because every single element takes part in the Gamaflor Raised Solutions.

Gamaflor access flooring is a **modular, structural, elevated floor** laid on a **solid framework** to create a void for the passage of mechanical and electrical services. This removable panel conception is also a very versatile

system, allowing **flexible positioning** of workstations and building services. It provides easy access to the sub-floor for repair and maintenance and allows future upgrading of services with **minimal disruption** to occupants.

Gamaflor access floors are frequently used in trendy and innovative office buildings, as well as in technical specialized areas such as data centers and computer rooms, where there is a requirement to route mechanical services and cables, wiring, and electrical supply.

---

# PAC.





# PAC.

This Raised Access Floor system has great benefits and a high quality aesthetic. There is a wide range of floor panel finish options (natural and synthetic) suitable for any interior design giving to all varieties an **innovative look**. The system provides more configuration versatility and endless distribution of space possibilities as well as significant **reduction of the cabling system visibility**.

The installation of a Raised Access Floor Polygroup GamaFlor needs **no dirty work** and **maintenance is comfortable** and easy throughout the building. Access Flooring Systems are highly **reusable** when being disassembled. In any new configuration, the system remains flexible; instantly adapting to building new areas and thus reducing investment costs.

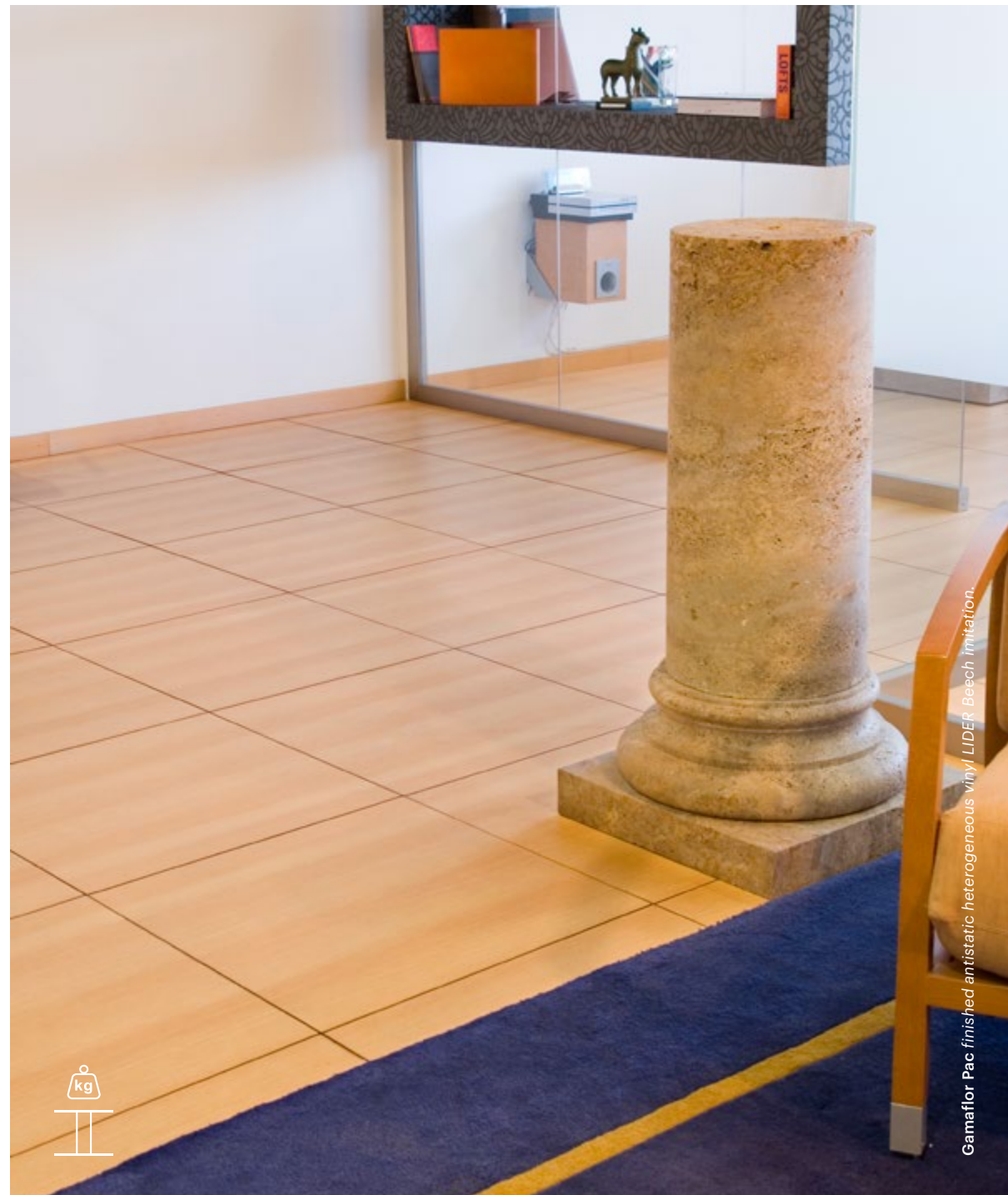

Gamaflor Pac finished antistatic heterogeneous vinyl LIDER Beech imitation.

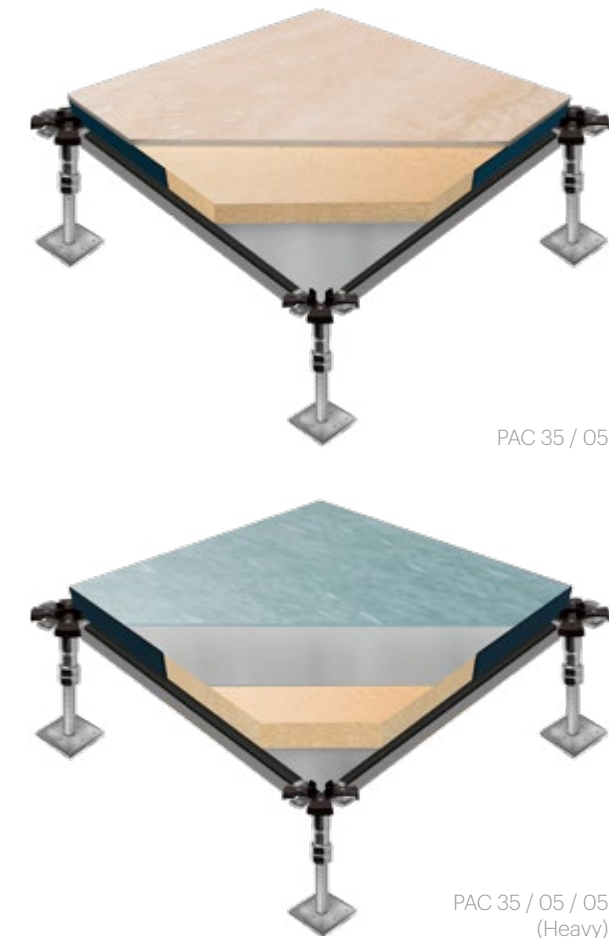

- Chipboard core
- Perimeter edge
- Floor covering
- Steel

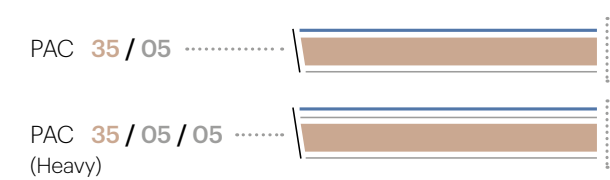

Designed to be considered as a functioning unit, PAC system consists of tiles of panel dimension option of 600 x 600 mm. or 750 x 750 mm., with high density chipboard core, PVC perimeteral edge band and bottom panel galvanized steel sheet of 0,5 mm. reinforcement. The top panel is highly configurable offering a wide range of pavement finish options. The tiles are supported in steel pedestal with an adjustable final height option of 75 to 1900 mm.

This System has a significant **high resistance** features to load and fire retard balance as well as **dynamic and static**

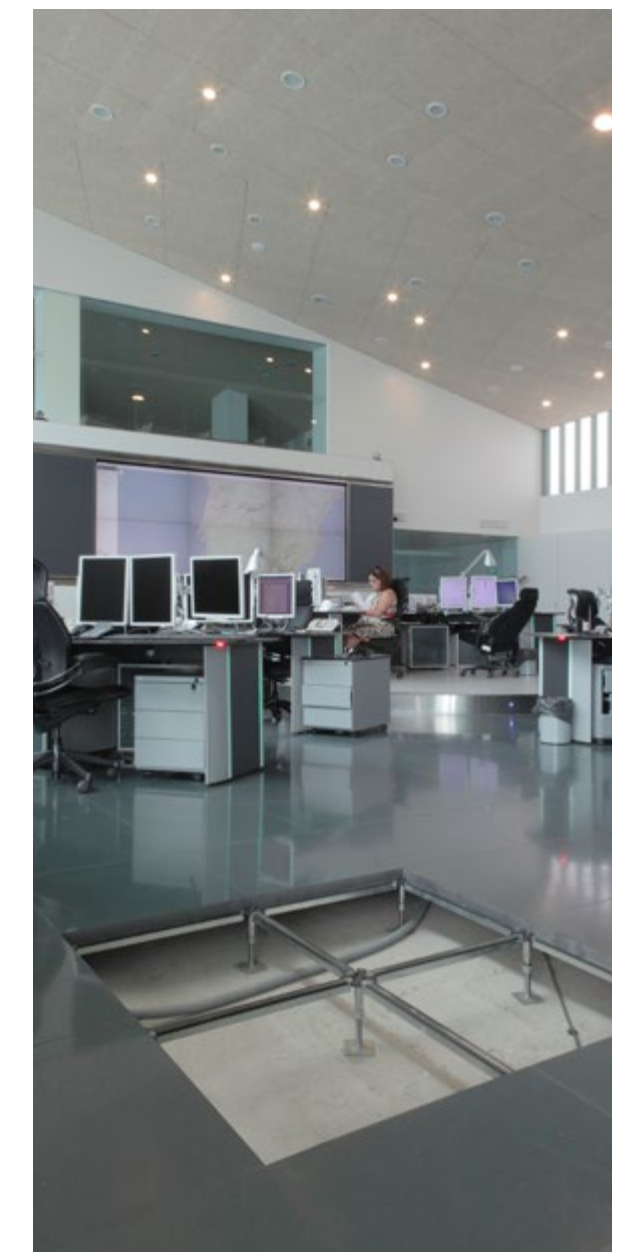

**load performance.** Structural integrity makes this system **compact and stable**. The GamaFlor PAC panel composition can be configured according to different core nominal thickness averages of 30, 35 and 40 mm. respectively in compliance with the load resistance rates required.

Panel dimension option: 600 x 600 mm / 750 x 750 mm.  
 Core Thickness option: 30 - 35 or 40 mm.  
 Core Density: 720 kg/m<sup>3</sup> ± 10% according to intl. standards.  
 Edge band Thickness: 1,5 mm.  
 Bottom: Galvanized Steel sheet Z - 275 0,5 mm Thickness.



# BANK.





# BANK.

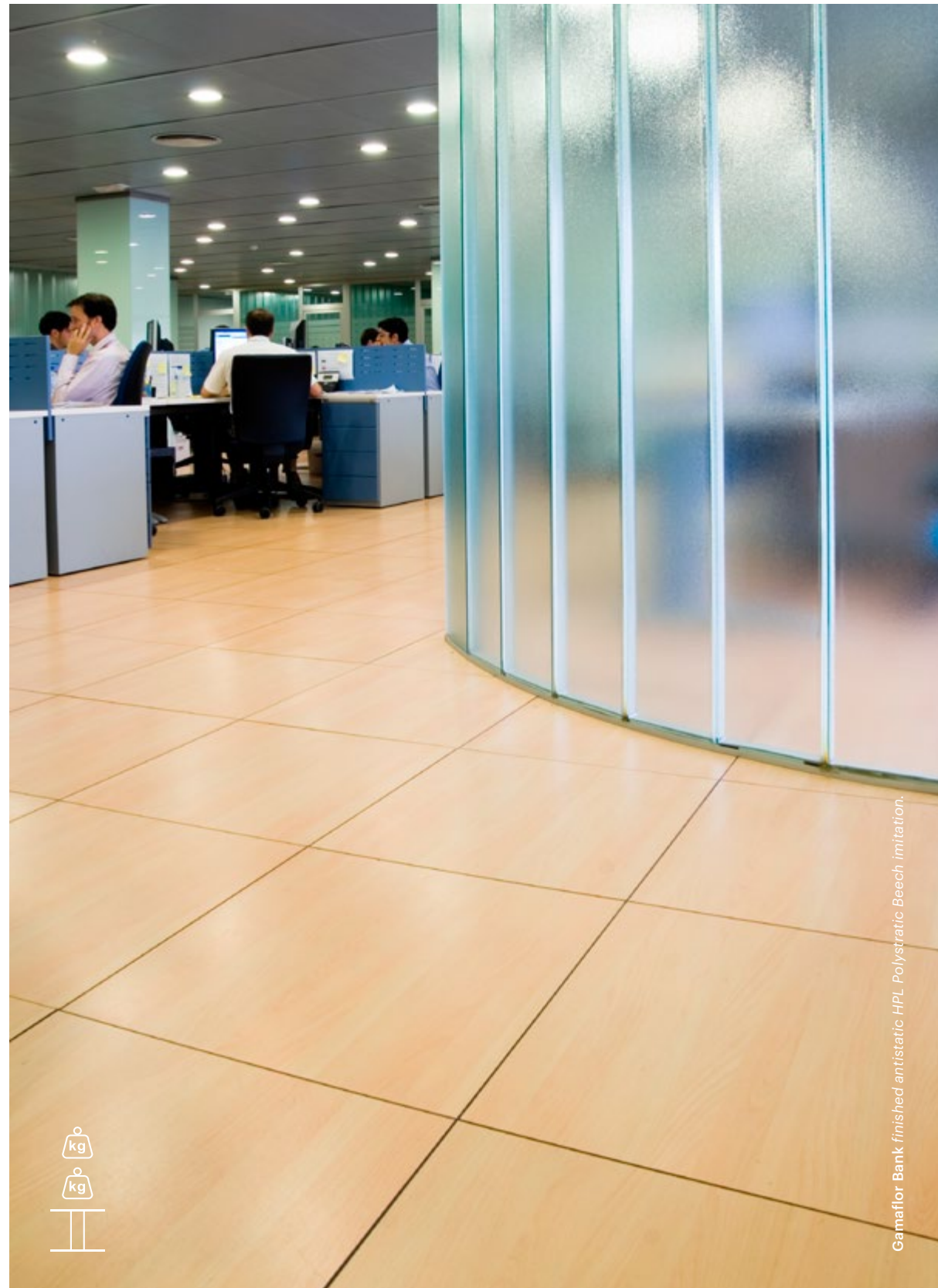

Gamaflor Bank finished antistatic HPL Polystyatic Beech imitation.

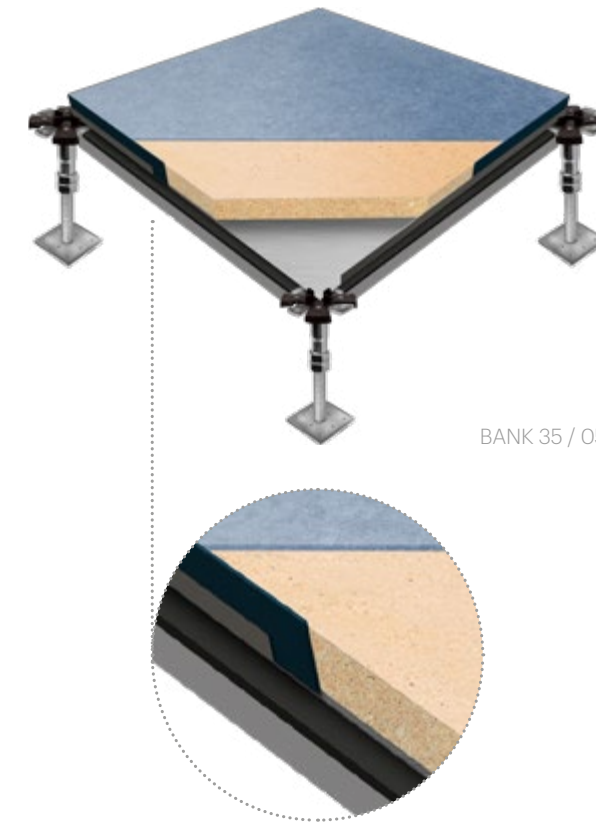

BANK 35 / 05

- Chipboard core
- Perimeter edge
- Floor covering
- Steel

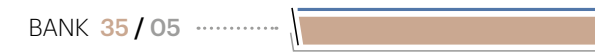

Designed to be considered as a functioning unit, BANK system consists of tiles of 600 x 600 mm., with high density chipboard core, PVC perimetral edge band and bottom panel galvanized steel tray encased of 0,5mm. The top panel is highly configurable offering a wide range of pavement finish options. The tiles are supported in steel pedestal with an adjustable height option of 75 to 1900 mm.

This System has a significant **high resistance** features to load and fire retard balance as well as **dynamic and static load performance**.

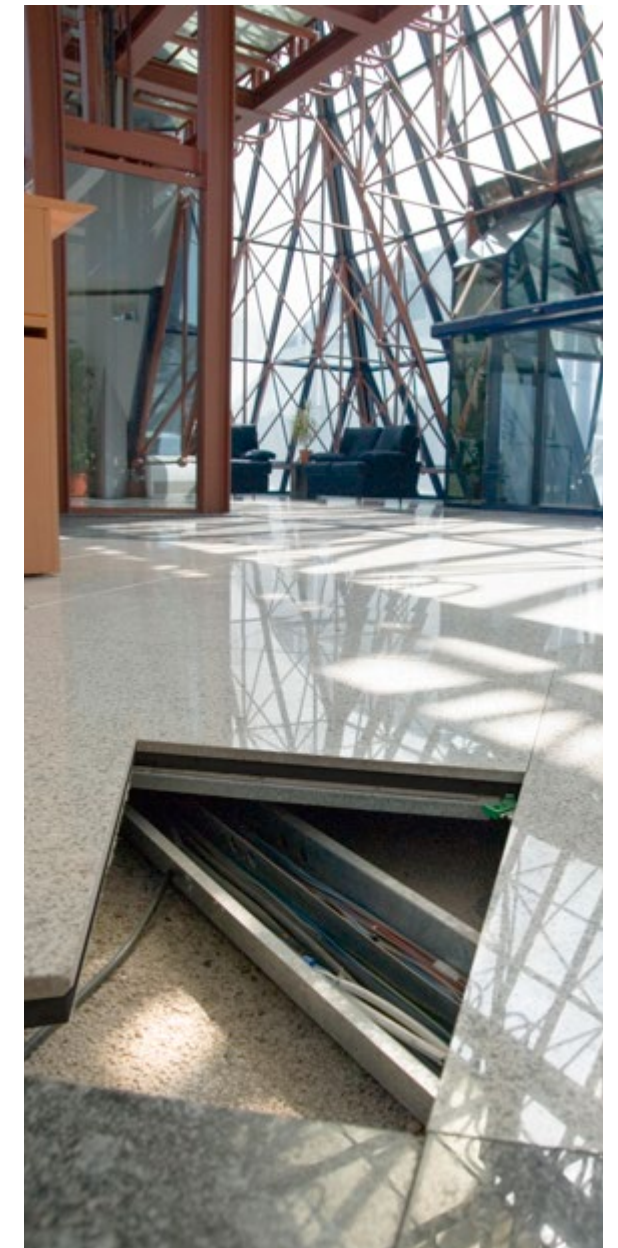

Structural integrity makes this system compact and stable. The Gamaflor BANK panel composition can be configured according to different core nominal thickness averages of 30, 35 and 40 mm respectively in compliance with the load resistance rates required.

- Panel dimension: 600 x 600 mm.
- Core Thickness option: 30 - 35 or 40 mm.
- Core Density: 720kg/m<sup>3</sup> ± 10% according to intl. Standards.
- Edge band Thickness: 1,5 mm.
- Bottom: Galvanized Steel sheet tray 0,5 mm Thickness.



# Pac / Bank SOVEREIGN.





# Pac / Bank SOVEREIGN.



Continuous effect

Gamaflor Pac / Bank finished antimicrobial heavy traffic carpet.

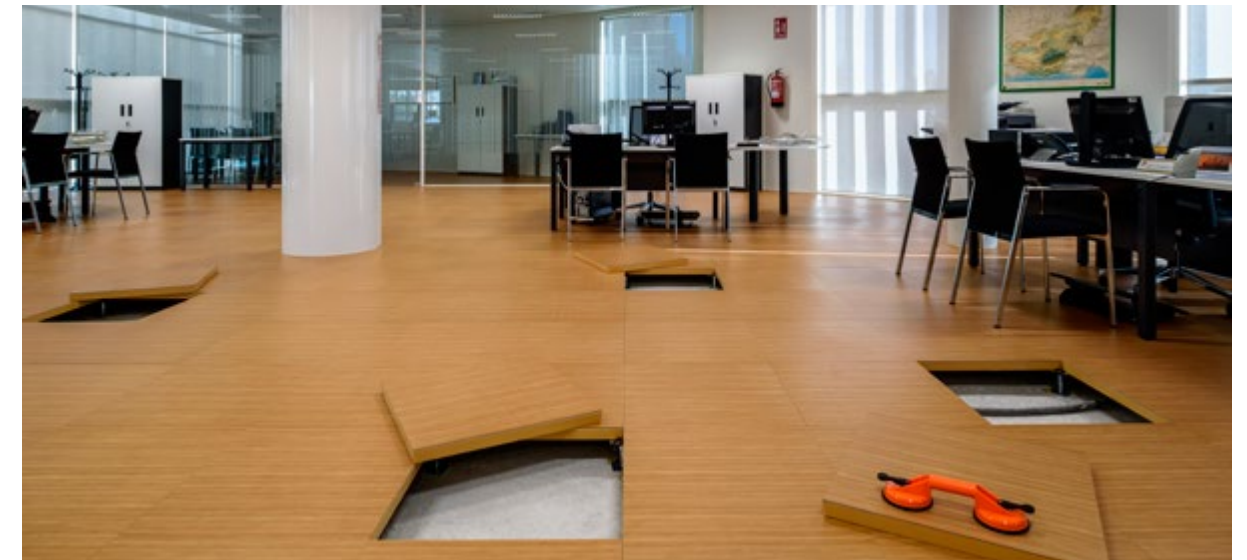

- Chipboard core
- Perimeter edge
- Floor covering
- Steel

PAC 35 / 05 SOVEREIGN

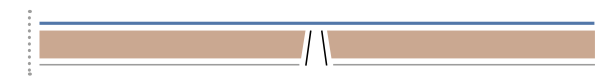

PAC 35 / 05 / 05 HEAVY SOVEREIGN

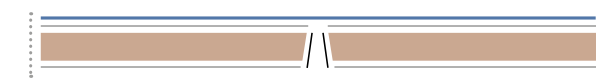

- Chipboard core
- Perimeter edge
- Floor covering
- Steel

BANK 35 / 05 SOVEREIGN

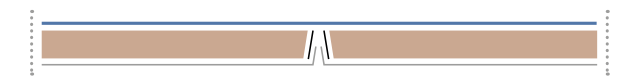

BANK 35 / 05 / 05 HEAVY SOVEREIGN

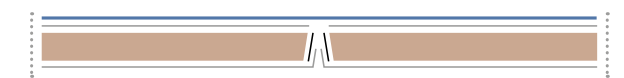

Influenced by the new raised floor design criteria, the Sovereign System is an excellent addition to the PAC / BANK raised floor new generation range. In our effort to continuously create diverse and versatile spaces more alive and dynamic than ever giving to all sites where this option is installed an **innovative look**.

The main difference in this range is the beveled perimetral edge leaving it undetectable in a secondary layout. The **invisible perimetral edge** appearance helps to create a subtle distinction between each individual panel, showcasing their own individual character and getting a continuous view effect.

This kind of flooring is often preferred by those who are looking for a more **natural looking floor** and **homogeneous appearance**.

This additional configuration enhances the technical features to the highest level. This system meets the highest classification for load resistance under the **European standard EN-12825** gaining a **Class 6** rating of use.

The perimetral beveling produces the **undetectable appearance of the edge** in a secondary layout helping to create a subtle distinction between each individual panel, showcasing their own individual character and getting a continuous view effect. The main difference in this range is the **additional steel top** finish which provides **extra protection to the panel core**.

This kind of flooring is often preferred by those who are looking for a more natural looking floor and **homogeneous appearance** without compromising the **high resistance** level requirements.



# FULL STEEL.





# FULL STEEL.



Gamaflor Full Steel finished anti slip stainless steel.

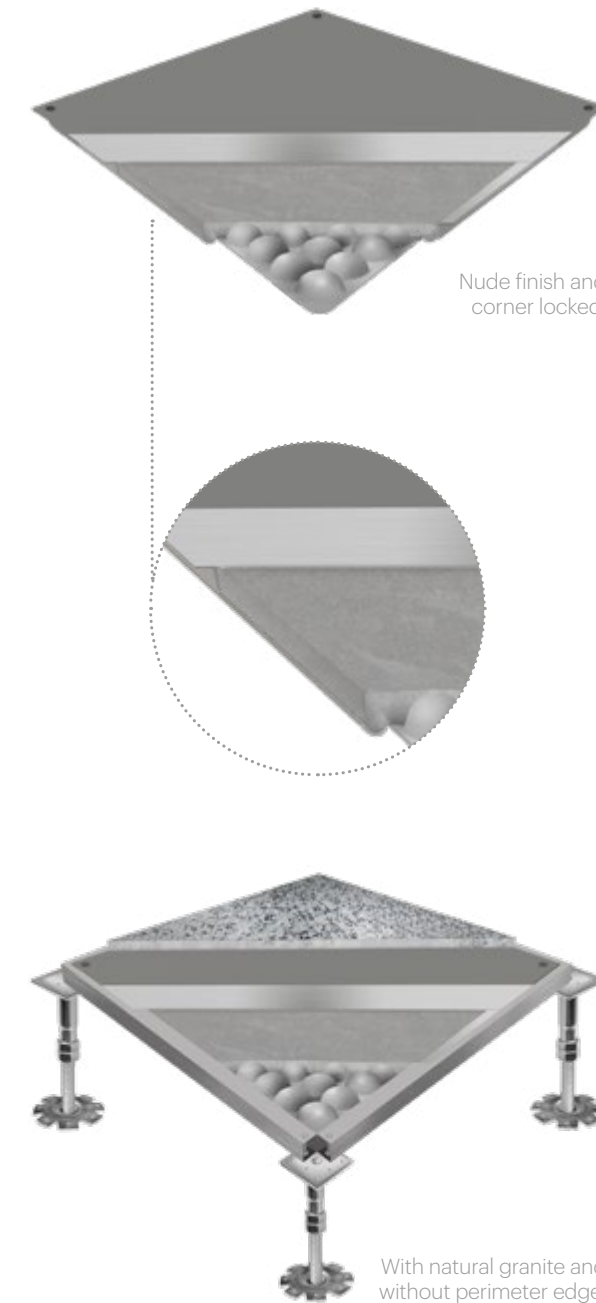

Designed to be considered as a functioning unit, Full Steel System consists of tiles of 600 x 600 mm., manufactured with 2 electro welded steel sheets and cement core infilled. The top panel is highly configurable offering a wide range of pavement finish options. The tiles are supported in steel pedestal with an adjustable final height option of 75 to 1900 mm.

This System has a significant **high resistance** features to load and fire retard balance as well as **dynamic and static load performance**. The inert composition (steel cement

panel) rate this system as one with **0% humidity absorption** classification obtaining the **lowest thermal conductivity level** versus other traditional raised floor panels. Structural integrity makes this system compact and stable.

Panel dimension: **600 x 600 mm.**  
 Thickness option: **34 mm.**  
 Top: **smooth steel sheet.**  
 Bottom: **Thermoforming steel tray.**  
 Top coating: **Epoxy protection painting.**



# FULL STEEL.



Panels can be classified according to load resistance into:

- Light ..... 0,7 / 0,7 mm.
- Heavy Medium ..... 0,9 / 0,9 mm.
- Heavy ..... 0,9 / 1,2 mm.
- Extra Heavy ..... 1,2 / 1,5 mm.
- EH 2000 ..... 1,5 / 2,0 mm.

This additional tailored configuration does not alter the features aforementioned but **enhances them to the highest level.**

- Cement
- Epoxy protection painting
- Floor covering
- Steel

Full steel bare finished and corner locked .....

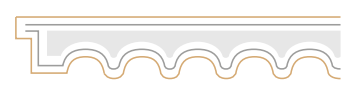

Full steel with floor covering .....

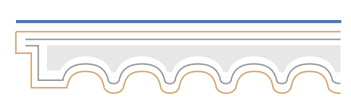







# STRUCTURE.

Conceived as a unitary whole solution, the Gamaflor frame structure consists of steel pedestals and steel stringers combined with each other as system ensuring the **highest stability** performance in the event of lateral movement or even earthquakes.

The Gamaflor pedestal is designed as structural element used interchangeably for PACK / BANK and Full Steel (in the reversed position) to support the panels raising it off the floor slab to create a void space for mechanical and electrical services distribution.

Its adjustable height possibility (75 to 1900 mm) allows the panels to be **installed level regardless the possible unevenness** in elevation of the floor slab. It has 2 heads of 3 mm steel, assembled to an 18 mm metric threaded rod with double steel nut anchor bolts that guarantees stability and level of the system over time.

Structure is complemented with **acoustic insulated** steel stringers used to connect access floor and pedestal together (clipped or screwed), thus providing lateral **stability** to the system and floor supports.



## Pac / Bank

## Full Steel

### REVERSIBLE PEDESTALS

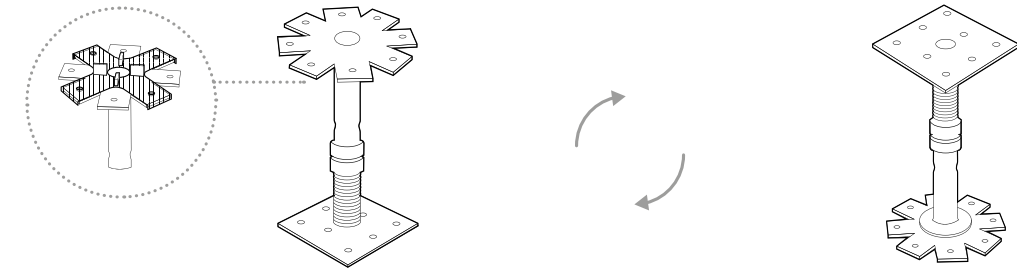

### STRINGERS

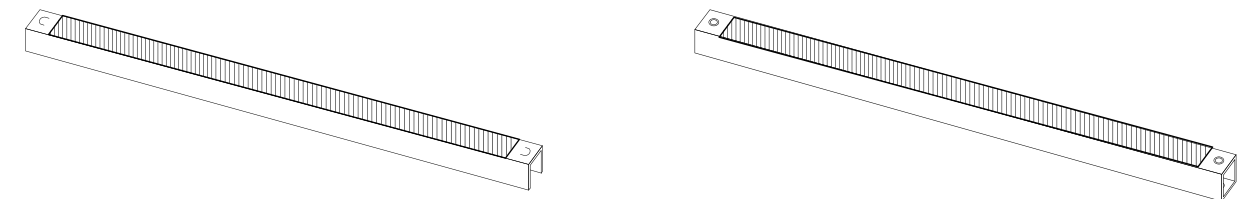

### ANCHORAGE

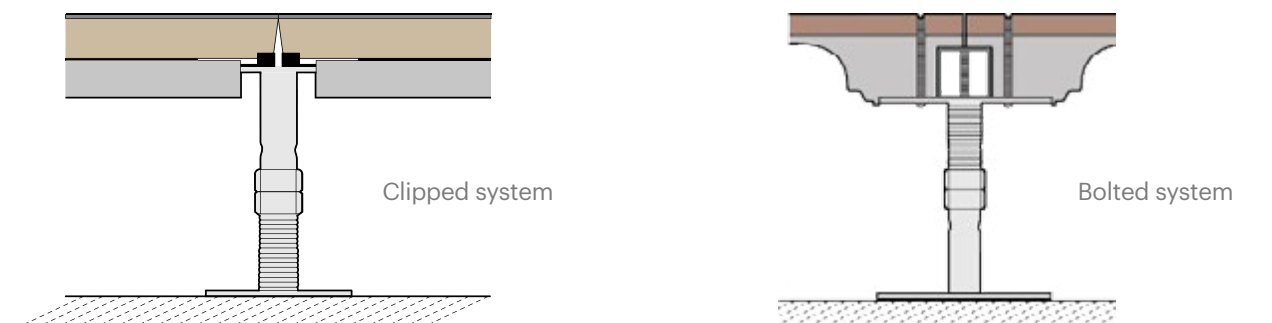

### ANTI-SEISMIC

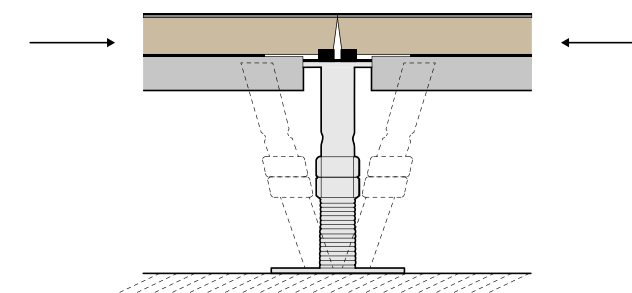



## Light finishes.

Gamaflor raised floor systems are characterized by offering the possibility of being finished directly from factory with a wide variety of aesthetic possibilities to choose from.

Light finishes range, offer multiple choices that will turn the system into a fully "panel by panel" accessible system without needing to even remove or install finish on each relocated panel.

A wide range of floor pavement options, suitable for any interior design, like antistatic HPL (High pressure Laminated), Antistatic HPV (High pressure vinyl), ESD homogeneous vinyl, Linoleum, Rubber, antistatic carpet beyond others, provide more configuration versatility increasing the aesthetics value of the space as well as the best performance features on the market.



Gamaflor Pac & Bank finished antistatic heterogeneous vinyl LIDER oak imitation

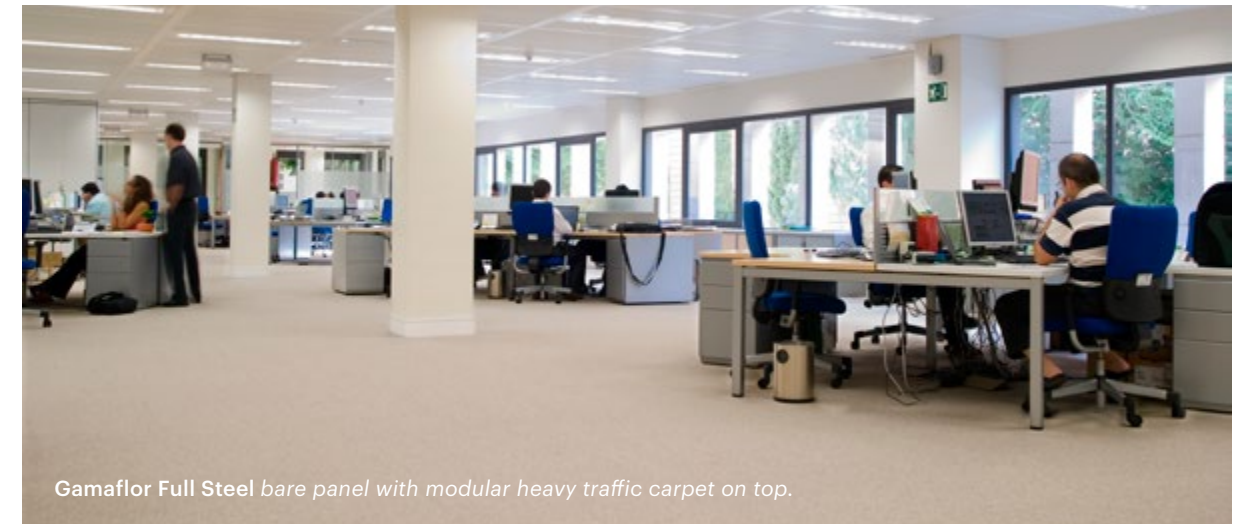

Gamaflor Full Steel bare panel with modular heavy traffic carpet on top.



Gamaflor Pac & Bank finished with antistatic carpet (bonded on factory).

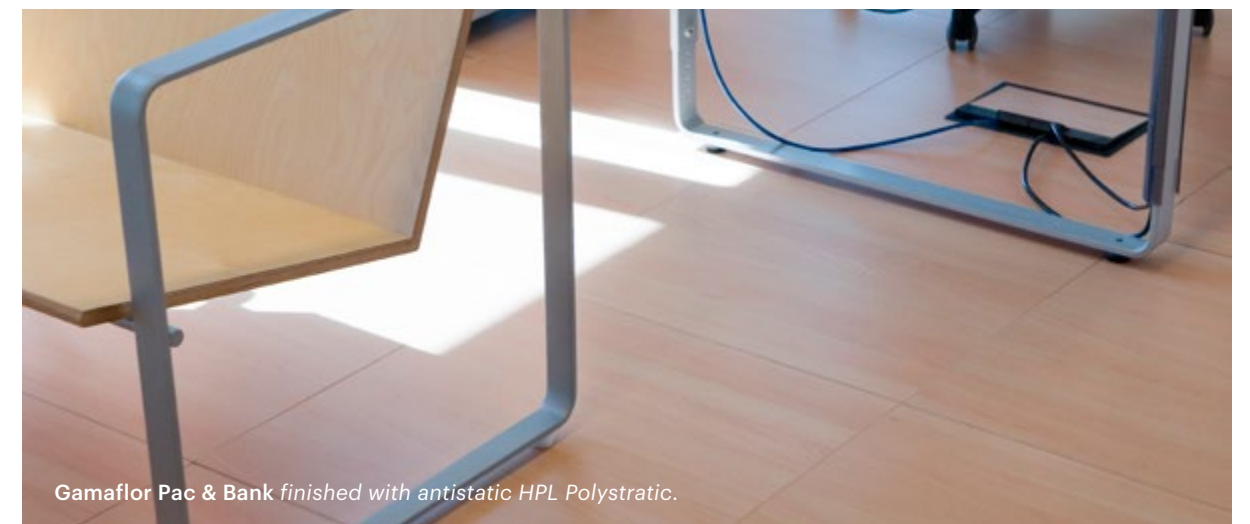

Gamaflor Pac & Bank finished with antistatic HPL Polystratic.



## Hard finishes.

The vast majority of public as well as private buildings are demanding raised floor systems finished from factory as a distinguishing element serving to differentiate as a part of the project themselves. An unrivalled awe-inspiring designing concept together with the cozy warmth of natural elements

enriches Polygroup's hard finish catalogue developed in exclusive for Gamaflor raised floor systems to the highest aesthetics value enhanced by granite, natural & exotic wood, porcelain or stainless steel.

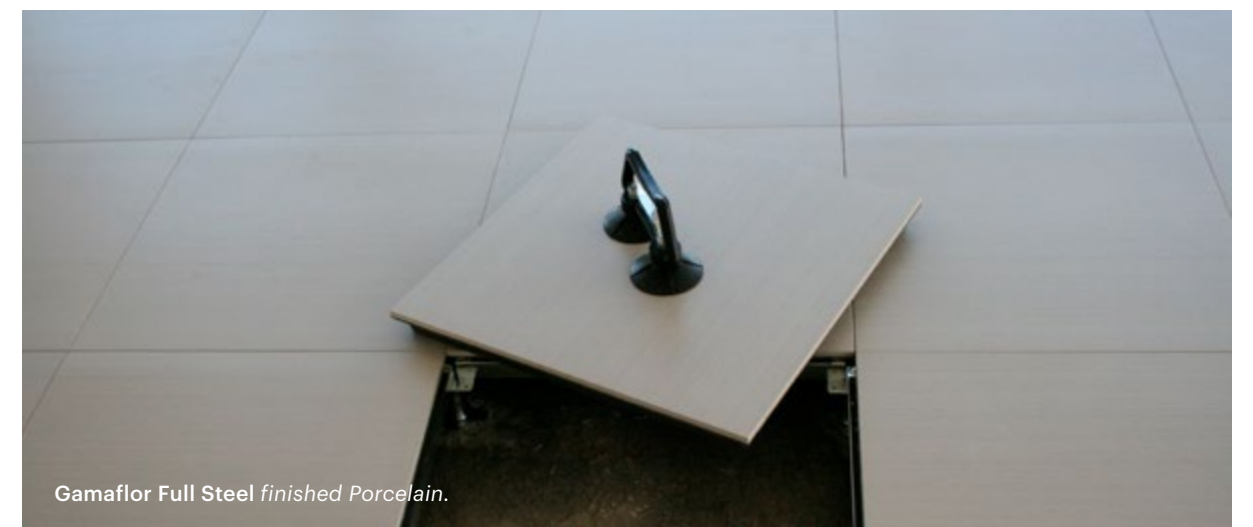



## Accessories.

Complementing the Gamaflor Solution, a variety of accessories suit all kind of architectural and technical needs to complete the Raised flooring System installation with solid success.

We offer a complete accommodation line of **ramps**, **access steps** and **hand rails** that ensures access for all is achieved.

**Ventilation grilles**, **air diffusers**, **electrical boxes**, **panel** and **carpet lifters** finish out and maintain your new or existing installation in optimum conditions from day one.

Access Floor Gamaflor is able to create **flexible** and cost **effective solutions** without ever losing its structural integrity.

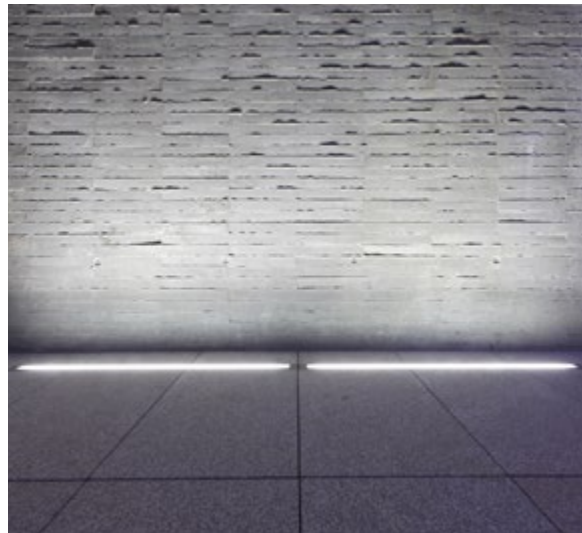

# Accessible utilities

- Ramps
- Rail protections
- Hand rails
- Ventilation grilles
- Air diffusers
- Electrical boxes
- Panel lifters
- Carpet lifters
- Skirting boards
- Steps of stairs
- Understeps
- Telephone connection boxes





# APPLICATIONS.

Gamaflor raised access floor systems are made with customers' needs in mind. Their efficiency and aesthetics make them versatile enough for new construction and renovation concepts in the most diverse of environments and uses such as office and governmental buildings, data rooms, theatres and concert rooms, airport and rail passenger terminals beyond others.

Polygroup offers the most comprehensive range of options. We promote suitable solutions to provide the architectural bedrock for spaces that are flexible, responsive, cost-efficient, and beautiful.

**Gamaflor System, suitable for any concept design.**

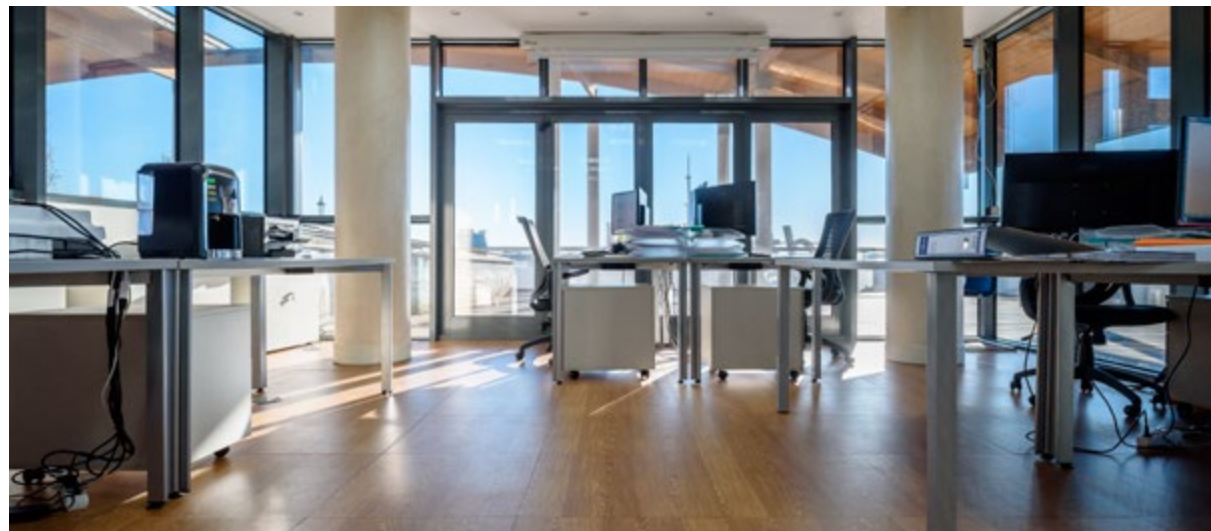

## Office spaces

As a space where employees will spend a lot of time and where clients will be welcomed, office interior needs to be well thought-out. A team spends the majority of their working day in an office environment, and the design of the workplace has a huge impact on their performance. We tailor every space transformation according to these facts re-designing tools and workspaces to enhance the energy of the team. Easy to obtain the open space wished without cables in the view.

*Typical Areas of Use:*

- \_ Governmental, Institutional and State buildings.
- \_ Corporate offices, International headquarters with its own corporate identity.
- \_ Speculative multi-tenant and retail office buildings.
- \_ Financial and insurance buildings. From branch offices to centralized large spaces.
- \_ Special design projects.



## Educational

We understand that the learning environment needs to be dynamic and inspiring to meet the continuous demand for a high quality educational experience.

Students need a safe, welcoming atmosphere to promote interaction, creativity and collaboration. Whether maintaining the traditional classroom or migrating to the more innovative approaches, educational spaces demand multiple usability accommodating different needs.

Cost-effective solutions that help these facilities achieve productive and comfortable learning environment are our specialty.

*Typical Areas of Use:*

- \_ Classrooms
- \_ Libraries
- \_ IT facilities
- \_ Learning spaces
- \_ Conference rooms



## Culture

Cultural buildings are characterized by their elegance and their routinely undergo reconfigurations. Raised access flooring systems are the perfect solution for this type of displays and exhibitions which are routinely set-up, disassembled or re-configured combining elegance and technology at once. At cultural buildings, raised technical floor systems are characterized by their exclusivity, innovation and safety. The possibility to build a grandstand with raised technical floors at different heights makes it the most suitable material to build theatres, concert hall, opera houses.

Keeping an eye on this trend, POLYGROUP raised floors create easily modifiable systems for those who want to think outside the box and seek creative solutions because aesthetic & high performance do not have to be mutually exclusive.

*Typical Areas of Use:*

- \_ Theatres
- \_ Opera & Music halls
- \_ Museums
- \_ Lecture halls & Libraries
- \_ Conventions and Conferences centers.



# APPLICATIONS.



## Passenger Transport Terminals

This kind of spaces combine outstanding functionality with modern design. Polygroup will take perfection to the most singular design, thanks to its tailored high quality, high flooring that will make your project unique.

Amenities like exclusive lounges make passengers feel comfortable. Using environmental friendly technologies will complete your project efficiently and to the most stringent international quality standards. A terminal has multiple halls, common areas, shopping malls, cafeterias, restaurants, checking counters. Areas will improve their technical and aesthetics appearance with the use of Polygroup technical flooring.

We are a trustworthy partner to develop control areas and emergency rooms, as our specialized team works on solutions that provide audio, as well as fire protection; they will be present all along the process of construction of your control hall, thus guaranteeing its quality and safety.

*Typical Areas of Use:*

- \_ Airports.
- \_ Control Tower.
- \_ Emergency rooms.
- \_ Technical halls.
- \_ Luggage areas.
- \_ Commercial areas.
- \_ Maritime & Seaport areas.
- \_ Railway stations.
- \_ Operational control rooms.



## Historic Building Restoration

Fortunately, many older buildings have tall floor to floor heights, which give the architect two options: a raised access floor or a very deep ceiling space. Today's demand for high-tech space requires significant cabling services. Older buildings are often considered obsolete. Gamaflor makes it easy to upgrade and adapt improving cable non visibility which may make the space even more attractive to tenants. It's free standing components don't attach to or damage the building at the subfloor or walls.

Raised Access Flooring is an attractive choice for buildings that are being completely remodeled. It offers the same systems quality and flexibility as a new building preserving the integrity of historic space structures and returning to original state.

*Typical Areas of Use:*

- \_ Museums.
- \_ Historic buildings.
- \_ Old warehouse spaces.
- \_ Remodeled offices.



## Leisure

The perfect recreation environment must address a variety of needs. These needs include maintaining high-quality clean air, attenuating noise, responding to equipment layout and technological changes quickly and easily.

Historically, leisure spaces have relied on concrete trenches and deck systems for wire management. Gamaflor adaptive cabling distribution system provides greater flexibility and organization to manage cabling requirements, making it the best solution for casino for example. Gamaflor can easily handle the cable capacity required to contain the cabling and other conduits needed to support slot machines, gaming tables and security. Radio and television studios need specific solutions which guarantee high levels of acoustic isolation, an optimal special acoustics or high functionality.

*Typical Areas of Use:*

- \_ Hotels & Resorts.
- \_ Casinos.
- \_ Cinemas.
- \_ Television & Radio Studios.
- \_ Stage and Studio Rooms.



## Technical facilities

A single electrostatic shock in the wrong place may be determining for the right functioning of equipment. Data processing rooms, IT and laboratories require a maximum of technical accuracy when choosing the appropriate construction materials and in particular with high technical flooring.

Load capacity, air conductivity and electrostatic control are decisive when deciding the flooring for a data processing room, a control center or a clean hall. Polygroup develops systems especially designed for the purpose of providing both the flooring and the necessary safe and technologically advanced acclimatization elements to data and information storing industry.

*Typical Areas of Use:*

- \_ IT Control centers.
- \_ Communications rooms.
- \_ Emergency rooms.
- \_ Laboratory & clean rooms.
- \_ Electrical rooms & substations.
- \_ Energy Plants EPC Buildings.
- \_ Data processing centers.
- \_ Training and research rooms.





# Gamaflor Out-Floor System

---

---

## What is Out-Floor System?

*"An assembly of components for outdoor and free air spaces creating a comfortable and stable footstep in areas of public use".*

This Raised Access Floor system has great benefits and a high quality aesthetic for **outdoor** and **free air spaces** creating a comfortable and stable footstep in areas of public use. Thanks to its application versatility, this system

will add an awe-inspiring touch to leisure spaces such as restaurants, hotels or terraces radiating modern edge with an eclectic twist.

---

OUTDOOR



# OUT-FLOOR.



Gamaflor Out-Floor finished with anti slip porcelain marble design.



Designed to be considered as a functioning unit, Out-Floor panels remain **unalterable to meteorological agents**. This System consists of configurable tiles of 600 x 600, 300 x 600 or 500 x 500 mm., with high density inert core composition, top finished in **anti-slip ceramic** or **granite stony covering**.

There is a huge variety of finish color options to suit the building design criteria.

Panel dimension option: 600 x 600, 300 x 600 or 500 x 500 mm.

Core Thickness option: 15 mm.

Antislip porcelain granite: 10 / 12 mm.

All these components are joined by a security and stable membrane providing **resistance** and **durability** to the system.

The tiles are supported in polypropylene plots resistant to meteorological agents and adjustable in height ensuring floor level. Panels are 4 mm separated among themselves to **help the water drain**. Structural integrity makes this system **compact** and **stable**.

Core Density: high Density concrete 2.000 kg/m<sup>3</sup> reinforced by cellulosic organic fibre according to intl. Standards.



# Gamaflor Eco Thermal System (GETS)

---

Under Floor Air Distribution

# UFAD

---

Under Floor Air Distribution (UFAD) systems provide the ability to address all of the factors required to create the perfect indoor environment becoming a key element of the sustainable space facilities design process. UFAD takes an important step forward to address the next generation of environmental conditioning systems.

Gamaflor Eco Thermal System provides a better indoor air quality, improved comfort control and enhance acoustics meeting nowadays environmental standards.

---



# GETS. How does it work?

Instead of air being introduced through a traditional ducted overhead system, air is distributed via the plenum space under a raised access floor system and introduced through a series of grilles and adjustable diffusers which are installed in the raised floor panels and discharge air to small areas in the space enabling facilities to maintain comfortable temperatures and ensuring high indoor air quality for occupants, while reducing the costs of distributing power and data cabling.

The primary benefit of using GAMAFLOR raised floor, from a cooling standpoint, is to deliver cold air where it is needed, with very little effort. This results in a system that can be more energy efficient, comfortable, and provides better ventilation and improved indoor air quality.

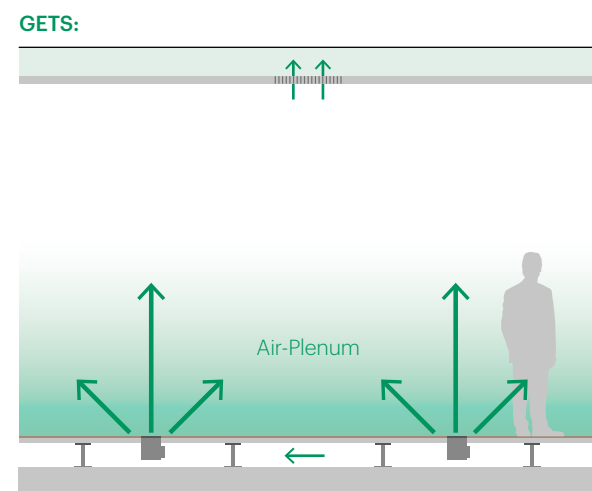

Gamaflor Eco Thermal System air delivery system uses raised access floor and temperature controlled zone air diffusers and grilles for ultimate air quality and comfort.

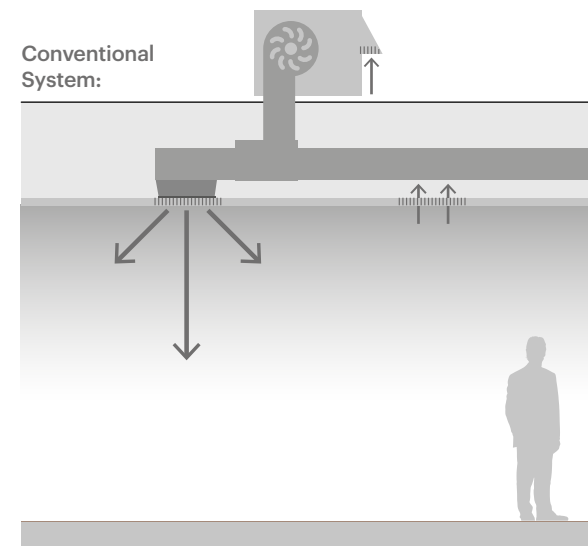

Overhead systems may require more fan energy to overcome static losses of generating the mixing, airflow patterns required within the space.

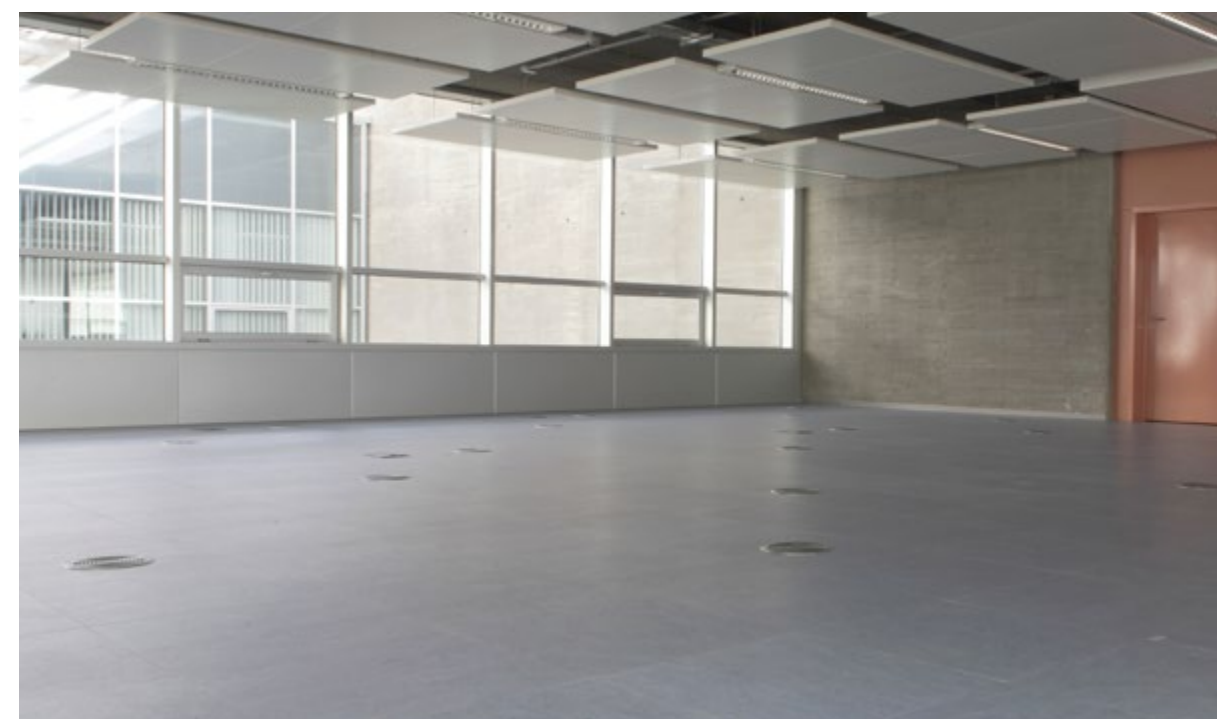

## ECO THERMAL CONTROL SYSTEMS COMPONENTS

Comfort space optimal delivery of clean and conditioned air into the workspace is under the floor, delivered by a system of components so flexible it can be rearranged or added in minutes.

**Air diffusers** delivers fresh, clean and conditioned air with minimum mixing and maximum efficiency. Each diffuser consists of an adjustable swirl plate located in a mounting basket and adapted to the Gamaflor floor raised floor panel. It catches any dirt or dust and prevents contamination of the space below the floor. The adjustable swirl plate allows the occupants to adjust their diffusers to a comfortable level in their space.

**Air distribution** diffusers have also been shown to provide good head to toe temperature variations without disrupting the benefits of a stratification zone.

**Underfloor fan** used for supply air from the floor plenum and increase the volume delivered to the room to meet the variable needs. It fits underfloor in the space between pedestals and the grids of the access flooring system. They are used for perimeter spaces, conference rooms and other spaces with a highly variable load pattern. Heating can be provided with either hot water coils or with electric heaters.

### GETS Features and Benefits

- Reduce energy** use saving 35% to 50% on electrical bill.
- Reduce operating** cost and reduces a buildings lifecycle cost.
- More cost effectiveness** than overhead systems.
- Eliminates 80% or more of the **required ductwork found** in overhead systems.
- Provide significantly better indoor **air quality and ventilation**.
- Improve occupant** comfort, productivity and consequently, health.
- Conditioned **air availability anywhere**.
- Adjustable air volume of free choice for occupants.
- Re-zone & add zones flexibility** in minutes. Enhance a buildings ability to change and adapt to its own needs and requirements.

### TARGET SPACES

- \_ New construction office spaces where frequent office changes are anticipated.
- \_ School spaces.
- \_ Cultural spaces.
- \_ Revitalization of old building existing structures.
- \_ Building with high ceilings and no place to run overhead air distribution.



UFAD is a key element in the design of sustainable office facilities; Under Floor Air Distribution (UFAD) systems provide LEED opportunities for their ventilation effectiveness, use of materials, and controllability.





# Data Center System

---

DATA  
CENTER

---

Today's mobile society is constantly consuming and creating data and subsequently depending on the storage, networking and processing of digital media, nearly all of it via or inside a data center. No doubt that data centers have become a vital industry expanding at a tremendous rate.

Gamaflor access floor systems offers inherently reliable, robustly designed and energy-efficient wide range of prod-

ucts that ensure data centers operate safely, reliably and efficiently.

The value of Polygroup's contribution to data centers is evident not only in the quality of individual products but also in the company's ability to give global assistance from the beginning designing project stage to complete installation.

---



# Key factors to consider when designing a Data Center.

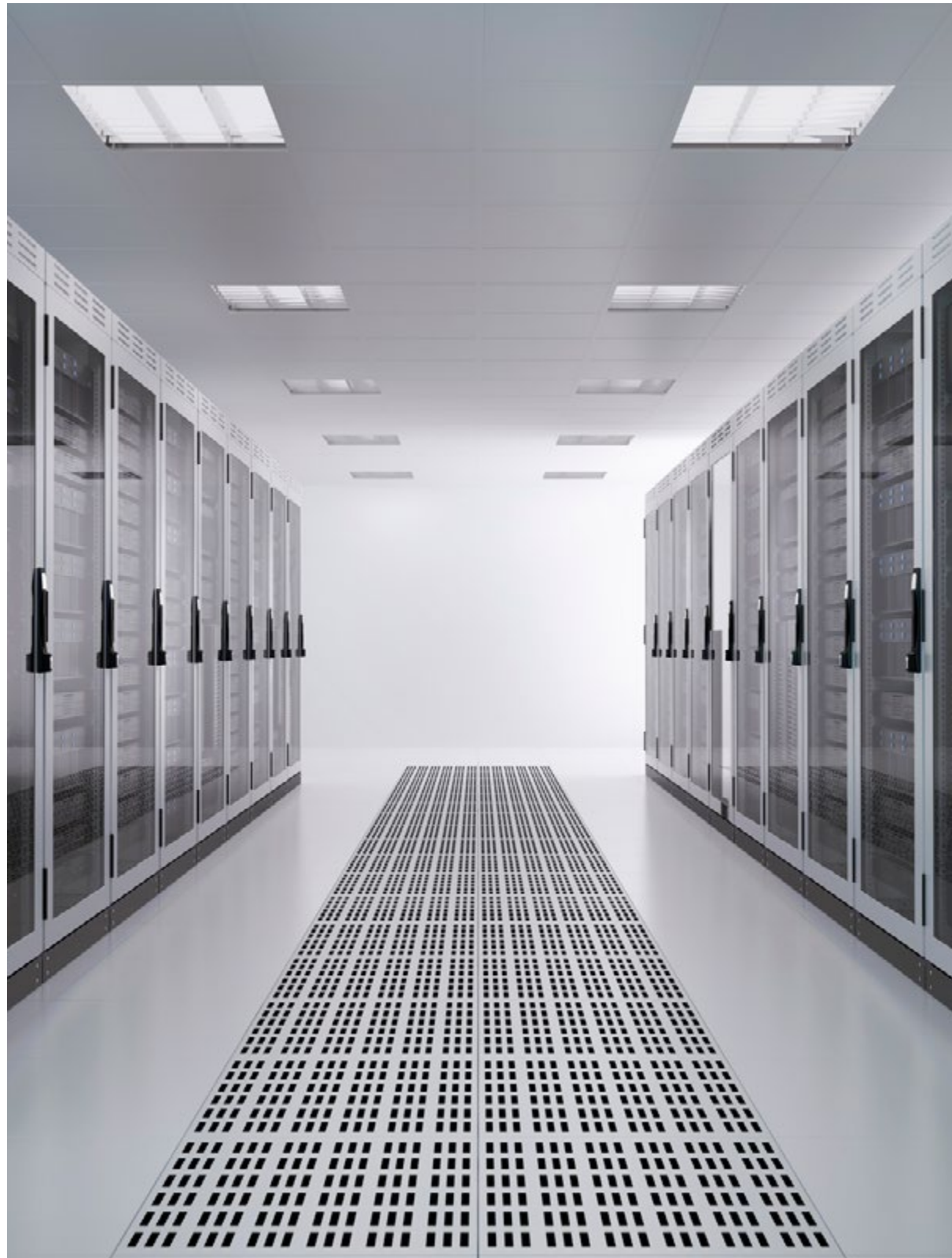

## ENERGY EFFICIENCY & AIR DISTRIBUTION COOLING

Gamaflor provide cost-effective solutions to meet the power usage effectiveness average demanded on today's data centers. Optimizing a cooling system in an integrated way involves minimizing the net cost of power while ensuring that cooling IT requirements are met.

Computer rooms and data centers use raised access floor systems composed of tiles supported on steel pedestals to deliver cold air to servers through the sub-floor or plenum where air conditioning is channeled. The primary benefit of

Gamaflor access flooring, from a cooling stand point, is to deliver cold air where it is needed, with very little effort, by simply swapping a solid tile for a perforated tile.

Good uniformity may be realized by arranging Gamaflor perforated floor tiles (e.g. 25%- open) in rows forming a "cold aisle". Equipment racks are then placed in rows along and facing each long side of the cold aisle, minimizing obstructions and leakage airflow by alternating hot and cold aisles.

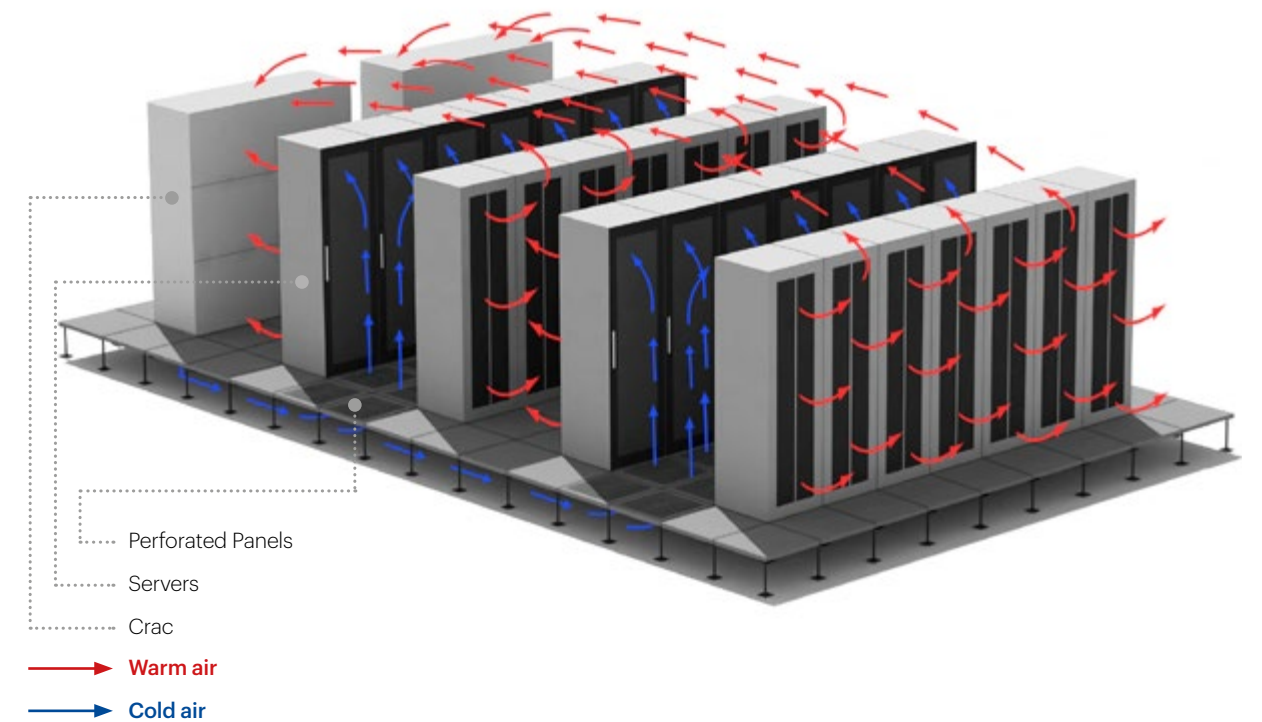

## PERFORATED PANELS OPTIONS

Every data center raised access flooring must be completed with GAMAFLOR steel perforated panels for assuring the air flow efficiency in cold aisles.

**Gamaflor G - 42**  
(42% Open area)

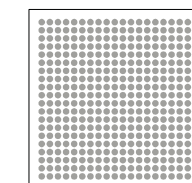

**Gamaflor G - 17**  
(17% Open area)

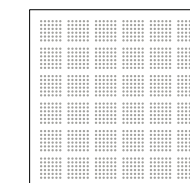

Panel can be produced with:

- Air flow control damper (closed)
- Air flow control direction damper

Other perforated panels are possible under request.



### ELECTROSTATIC ENVIRONMENTAL SAFETY ZONE

Raised access floor systems Gamaflor are developed for DPCS (Data Processing Centers) which require high levels of security due to its composition.

Due to the importance of DPCS security the appropriate choice of access floor system requires an exhaustive selection as it must have a low transverse electrical resistance to

help the electrical discharge generated by the IT equipment of the room.

POLYGROUP has developed electricity conductive systems and antistatic dissipative which will contribute to the smooth electricity running around the data center.

### CONDUCTILE SUPER-OR (CONDUCTIVE HOMOGENOUS VINYL)

This conductive vinyl flooring is the one used in spaces dependent on electronics as technical rooms that require electrostatic discharges data centers, laboratories, power

generators and electric rooms beyond other uses. Its press-based manufacturing system gives the flooring maximum resistance to intensive traffic.

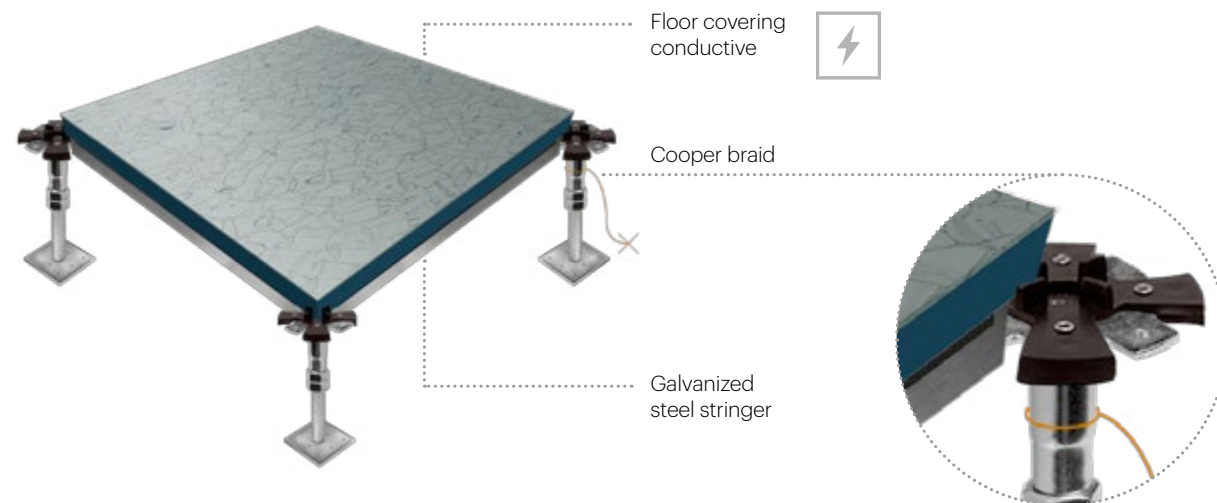

### SAFETY AND LOADING CAPACITY

As the Data Center requires the raised access floor designed under POLYGROUP for this area comply the highest standards of loading capacity, tested under the static and dynamic loading the systems will provide fully warranty to install on top the racks and servers machines without any movement on the flooring and obtaining the best acoustic support for this items.

International Companies specialized in data centers have homologated the more resistance systems of POLYGROUP which have been designed and produced under the more strictly engineers and designers requirements.

### Why Gamaflor Raised Floor systems in Data Centers?

Satisfies the necessity of an easy access to electrical, climatic, water and fireproof installations located under access raised floors.

Offers the highest fire rating according to European and American Standards.

Has approached well performance, particularly in handling high loads resistance for heavy equipment such racks and servers.

While classic data centers were struggling to cool these loads, Gamaflor Data system cooled them with ease.

Advanced load management which could be integrated with Gamaflor system, can lead to energy savings of 20 to 40 percent.

Gamaflor solution provides security, flexibility, efficiency and therefore trust fulness for all those involved in its building trade such as: designers, owners and data center managers.

The perfection of Gamaflor Systems ensures maximum system stability, avoiding floor vibrations.

### Gamaflor Data Center range:

Polygroup has developed access raised floor systems specially designed for Data Centers. The recommended systems for this areas are under the Conductivity products so we remarks the next products:

- GAMAFLOR PAC EXTRA HEAVY System.
- GAMAFLOR FULL STEEL System
- PERFORATED PANELS
- GLASS PANELS

Access floors Gamaflor systems enjoy maximum international certification of reputed laboratories obtaining the best qualifications under European and Cisca Norms.



Over the last several years we've seen increased interest in the use of raised access floors with underfloor service distribution as a way to improve indoor air quality, help make buildings more energy efficient, promote sustainable building practices and achieve LEED certification.



*Polygroup access floor, your key project resource.*





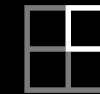

**Headquarter and factories**

P.I. Navisur, c/ Narciso, 5  
Costal Pode 41907, Valencina de la Concepción  
Seville, Spain.

Tel. (+34) 955 997 731  
Fax. (+34) 955 997 659  
*info@afpolygroup.com*

**America Branch**

Avenida Ricardo J. Alfaro, Century Tower, Mezzanine office M-9  
Panama City, Panama.

Tel. (+507) 385 5301  
*panama@afpolygroup.com*

**East Asia Branch**

14th Floor, South China Building 1-3 Wyndham Street, Central  
Hong Kong.

Tel. (+852) 2869 8814  
*asia@afpolygroup.com*

**General info**

*info@afpolygroup.com*

**Export Department**

*export@afpolygroup.com*

**Account Department**

*administracion@afpolygroup.com*

**News and external communication**

*marketing@afpolygroup.com*



 POLYGROUP

[www.accessfloorpolygroup.com](http://www.accessfloorpolygroup.com)